

# LM613

## Dual Operational Amplifiers, Dual Comparators, and Adjustable Reference

### General Description

The LM613 consists of dual op-amps, dual comparators, and a programmable voltage reference in a 16-pin package. The op-amps out-performs most single-supply op-amps by providing higher speed and bandwidth along with low supply current. This device was specifically designed to lower cost and board space requirements in transducer, test, measurement, and data acquisition systems.

Combining a stable voltage reference with wide output swing op-amps makes the LM613 ideal for single supply transducers, signal conditioning and bridge driving where large common-mode-signals are common. The voltage reference consists of a reliable band-gap design that maintains low dynamic output impedance ( $1\Omega$  typical), excellent initial tolerance (0.6%), and the ability to be programmed from 1.2V to 6.3V via two external resistors. The voltage reference is very stable even when driving large capacitive loads, as are commonly encountered in CMOS data acquisition systems.

As a member of National's Super-Block™ family, the LM613 is a space-saving monolithic alternative to a multi-chip solution, offering a high level of integration without sacrificing performance.

### Features

#### OP AMP

- Low operating current (Op Amp):  $300\ \mu\text{A}$
- Wide supply voltage range: 4V to 36V
- Wide common-mode range:  $V^-$  to  $(V^+ - 1.8\text{V})$
- Wide differential input voltage:  $\pm 36\text{V}$
- Available in plastic package rated for Military Temp. Range Operation

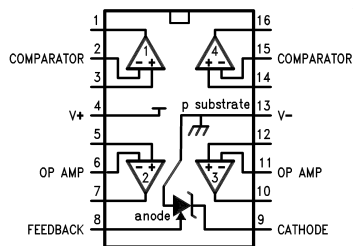
#### REFERENCE

- Adjustable output voltage: 1.2V to 6.3V
- Tight initial tolerance available:  $\pm 0.6\%$
- Wide operating current range:  $17\ \mu\text{A}$  to 20 mA
- Tolerant of load capacitance

### Applications

- Transducer bridge driver
- Process and mass flow control systems
- Power supply voltage monitor
- Buffered voltage references for A/D's

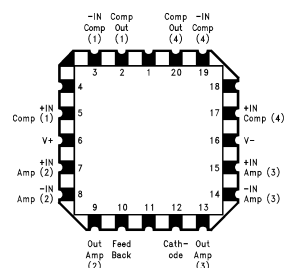
### Connection Diagrams



Top View

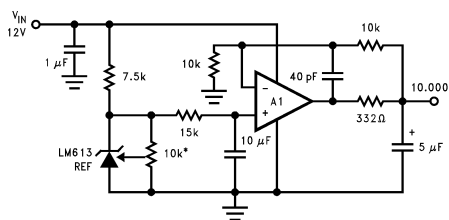
00922601

#### E Package Pinout



00922648

#### Ultra Low Noise, 10.00V Reference. Total output noise is typically $14\ \mu\text{V}_{\text{RMS}}$ .



00922643

\*10k must be low  
t.c. trimpot

**Absolute Maximum Ratings** (Note 1)

If Military/Aerospace specified devices are required, please contact the National Semiconductor Sales Office/Distributors for availability and specifications.

Voltage on Any Pin Except $V_R$ (referred to $V_{-}$ pin)	
(Note 2)	36V (Max)
(Note 3)	-0.3V (Min)
Current through Any Input Pin & $V_R$ Pin	$\pm 20$ mA
Differential Input Voltage	
Military and Industrial	$\pm 36$ V
Commercial	$\pm 32$ V
Storage Temperature Range	$-65^{\circ}\text{C} \leq T_J \leq +150^{\circ}\text{C}$
Maximum Junction Temp.(Note 4)	150 $^{\circ}\text{C}$

Thermal Resistance, Junction-to-Ambient (Note 5)	
N Package	100 $^{\circ}\text{C}/\text{W}$
WM Package	150 $^{\circ}\text{C}/\text{W}$
Soldering Information (10 Sec.)	
N Package	260 $^{\circ}\text{C}$
WM Package	220 $^{\circ}\text{C}$
ESD Tolerance (Note 6)	$\pm 1$ kV

**Operating Temperature Range**

LM613AI, LM613BI:	$-40^{\circ}\text{C}$ to $+85^{\circ}\text{C}$
LM613AM, LM613M:	$-55^{\circ}\text{C}$ to $+125^{\circ}\text{C}$
LM613C:	$0^{\circ}\text{C} \leq T_J \leq +70^{\circ}\text{C}$

**Electrical Characteristics**

These specifications apply for  $V_{-} = \text{GND} = 0\text{V}$ ,  $V_{+} = 5\text{V}$ ,  $V_{\text{CM}} = V_{\text{OUT}} = 2.5\text{V}$ ,  $I_R = 100 \mu\text{A}$ , FEEDBACK pin shorted to GND, unless otherwise specified. Limits in standard typeface are for  $T_J = 25^{\circ}\text{C}$ ; limits in **boldface type** apply over the **Operating Temperature Range**.

Symbol	Parameter	Conditions	Typical (Note 7)	LM613AM LM613AI Limits (Note 8)	LM613M LM613I LM613C Limits (Note 8)	Units
$I_S$	Total Supply Current	$R_{\text{LOAD}} = \infty$ , $4\text{V} \leq V_{+} \leq 36\text{V}$ (32V for LM613C)	450	940	1000	$\mu\text{A}$ (Max)
			<b>550</b>	<b>1000</b>	<b>1070</b>	$\mu\text{A}$ (Max)
$V_S$	Supply Voltage Range		2.2	2.8	2.8	V (Min)
			<b>2.9</b>	<b>3</b>	<b>3</b>	V (Min)
			46	36	32	V (Max)
			<b>43</b>	<b>36</b>	<b>32</b>	V (Max)
<b>OPERATIONAL AMPLIFIERS</b>						
$V_{\text{OS1}}$	$V_{\text{OS}}$ Over Supply	$4\text{V} \leq V_{+} \leq 36\text{V}$ ( $4\text{V} \leq V_{+} \leq 32\text{V}$ for LM613C)	1.5	3.5	5.0	mV (Max)
			<b>2.0</b>	<b>6.0</b>	<b>7.0</b>	mV (Max)
$V_{\text{OS2}}$	$V_{\text{OS}}$ Over $V_{\text{CM}}$	$V_{\text{CM}} = 0\text{V}$ through $V_{\text{CM}} =$ ( $V_{+} - 1.8\text{V}$ ), $V_{+} = 30\text{V}$ , $V_{-} = 0\text{V}$	1.0	3.5	5.0	mV (Max)
			<b>1.5</b>	<b>6.0</b>	<b>7.0</b>	mV (Max)
$\frac{V_{\text{OS3}}}{\Delta T}$	Average $V_{\text{OS}}$ Drift	(Note 8)	<b>15</b>			$\mu\text{V}/^{\circ}\text{C}$ (Max)
$I_B$	Input Bias Current		10	25	35	nA (Max)
			<b>11</b>	<b>30</b>	<b>40</b>	nA (Max)
$I_{\text{OS}}$	Input Offset Current		0.2	4	4	nA (Max)
			<b>0.3</b>	<b>5</b>	<b>5</b>	nA (Max)
$\frac{I_{\text{OS1}}}{\Delta T}$	Average Offset Current		<b>4</b>			pA/ $^{\circ}\text{C}$
$R_{\text{IN}}$	Input Resistance	Differential	1000			M $\Omega$
$C_{\text{IN}}$	Input Capacitance	Common-Mode	6			pF
$e_n$	Voltage Noise	$f = 100$ Hz, Input Referred	74			nV/ $\sqrt{\text{Hz}}$
$I_n$	Current Noise	$f = 100$ Hz, Input Referred	58			fA/ $\sqrt{\text{Hz}}$
CMRR	Common-Mode Rejection Ratio	$V_{+} = 30\text{V}$ , $0\text{V} \leq V_{\text{CM}} \leq (V_{+} - 1.8\text{V})$ CMRR = $20 \log (\Delta V_{\text{CM}}/\Delta V_{\text{OS}})$	95	80	75	dB (Min)
			<b>90</b>	<b>75</b>	<b>70</b>	dB (Min)

## Electrical Characteristics (Continued)

These specifications apply for  $V^- = \text{GND} = 0\text{V}$ ,  $V^+ = 5\text{V}$ ,  $V_{\text{CM}} = V_{\text{OUT}} = 2.5\text{V}$ ,  $I_{\text{R}} = 100\ \mu\text{A}$ , FEEDBACK pin shorted to GND, unless otherwise specified. Limits in standard typeface are for  $T_{\text{J}} = 25^\circ\text{C}$ ; limits in **boldface type** apply over the **Operating Temperature Range**.

Symbol	Parameter	Conditions	Typical (Note 7)	LM613AM LM613AI Limits (Note 8)	LM613M LM613I LM613C Limits (Note 8)	Units
<b>OPERATIONAL AMPLIFIERS</b>						
PSRR	Power Supply Rejection Ratio	$4\text{V} \leq V^+ \leq 30\text{V}$ , $V_{\text{CM}} = V^+/2$ ,	110	80	75	dB (Min)
		PSRR = $20 \log (\Delta V^+/V_{\text{OS}})$	<b>100</b>	<b>75</b>	<b>70</b>	dB (Min)
$A_{\text{V}}$	Open Loop Voltage Gain	$R_{\text{L}} = 10\ \text{k}\Omega$ to GND, $V^+ = 30\text{V}$ ,	500	100	94	V/mV
		$5\text{V} \leq V_{\text{OUT}} \leq 25\text{V}$	<b>50</b>	<b>40</b>	<b>40</b>	(Min)
SR	Slew Rate	$V^+ = 30\text{V}$ (Note 9)	0.70	0.55	0.50	V/ $\mu\text{s}$
			<b>0.65</b>	<b>0.45</b>	<b>0.45</b>	
GBW	Gain Bandwidth	$C_{\text{L}} = 50\ \text{pF}$	0.8			MHz
			<b>0.5</b>			MHz
$V_{\text{O1}}$	Output Voltage Swing High	$R_{\text{L}} = 10\ \text{k}\Omega$ to GND, $V^+ = 36\text{V}$ (32V for LM613C)	$V^+ - 1.4$	$V^+ - 1.7$	$V^+ - 1.8$	V (Min)
			<b><math>V^+ - 1.6</math></b>	<b><math>V^+ - 1.9</math></b>	<b><math>V^+ - 1.9</math></b>	V (Min)
$V_{\text{O2}}$	Output Voltage Swing Low	$R_{\text{L}} = 10\ \text{k}\Omega$ to $V^+$ , $V^+ = 36\text{V}$ (32V for LM613C)	$V^- + 0.8$	$V^- + 0.9$	$V^- + 0.95$	V (Max)
			<b><math>V^- + 0.9</math></b>	<b><math>V^- + 1.0</math></b>	<b><math>V^- + 1.0</math></b>	V (Max)
$I_{\text{OUT}}$	Output Source Current	$V_{\text{OUT}} = 2.5\text{V}$ , $V^+_{\text{IN}} = 0\text{V}$ , $V^-_{\text{IN}} = -0.3\text{V}$	25	20	16	mA (Min)
			<b>15</b>	<b>13</b>	<b>13</b>	mA (Min)
$I_{\text{SINK}}$	Output Sink Current	$V_{\text{OUT}} = 1.6\text{V}$ , $V^+_{\text{IN}} = 0\text{V}$ , $V^-_{\text{IN}} = 0.3\text{V}$	17	14	13	mA (Min)
			<b>9</b>	<b>8</b>	<b>8</b>	mA (Min)
$I_{\text{SHORT}}$	Short Circuit Current	$V_{\text{OUT}} = 0\text{V}$ , $V^+_{\text{IN}} = 3\text{V}$ , $V^-_{\text{IN}} = 2\text{V}$	30	50	50	mA (Max)
			<b>40</b>	<b>60</b>	<b>60</b>	mA (Max)
		$V_{\text{OUT}} = 5\text{V}$ , $V^+_{\text{IN}} = 2\text{V}$ , $V^-_{\text{IN}} = 3\text{V}$	30	60	70	mA (Max)
			<b>32</b>	<b>80</b>	<b>90</b>	mA (Max)
<b>COMPARATORS</b>						
$V_{\text{OS}}$	Offset Voltage	$4\text{V} \leq V^+ \leq 36\text{V}$ (32V for LM613C), $R_{\text{L}} = 15\ \text{k}\Omega$	1.0	3.0	5.0	mV (Max)
			<b>2.0</b>	<b>6.0</b>	<b>7.0</b>	mV (Max)
$\frac{V_{\text{OS}}}{V_{\text{CM}}}$	Offset Voltage over $V_{\text{CM}}$	$0\text{V} \leq V_{\text{CM}} \leq 36\text{V}$ $V^+ = 36\text{V}$ , (32V for LM613C)	1.0	3.0	5.0	mV (Max)
			<b>1.5</b>	<b>6.0</b>	<b>7.0</b>	mV (Max)
$\frac{V_{\text{OS}}}{\Delta T}$	Average Offset Voltage Drift		<b>15</b>			$\mu\text{V}/^\circ\text{C}$ (Max)
$I_{\text{B}}$	Input Bias Current		5	25	35	nA (Max)
			<b>8</b>	<b>30</b>	<b>40</b>	nA (Max)
$I_{\text{OS}}$	Input Offset Current		0.2	4	4	nA (Max)
			<b>0.3</b>	<b>5</b>	<b>5</b>	nA (Max)
$A_{\text{V}}$	Voltage Gain	$R_{\text{L}} = 10\ \text{k}\Omega$ to 36V (32V for LM613C) $2\text{V} \leq V_{\text{OUT}} \leq 27\text{V}$	500			V/mV
			<b>100</b>			V/mV
$t_{\text{r}}$	Large Signal Response Time	$V^+_{\text{IN}} = 1.4\text{V}$ , $V^-_{\text{IN}} = \text{TTL Swing}$ , $R_{\text{L}} = 5.1\ \text{k}\Omega$	1.5			$\mu\text{s}$
			<b>2.0</b>			$\mu\text{s}$
$I_{\text{SINK}}$	Output Sink Current	$V^+_{\text{IN}} = 0\text{V}$ , $V^-_{\text{IN}} = 1\text{V}$ , $V_{\text{OUT}} = 1.5\text{V}$	20	10	10	mA (Min)
			<b>13</b>	<b>8</b>	<b>8</b>	mA (Min)
		$V_{\text{OUT}} = 0.4\text{V}$	2.8	1.0	0.8	mA (Min)
			<b>2.4</b>	<b>0.5</b>	<b>0.5</b>	mA (Min)

## Electrical Characteristics (Continued)

These specifications apply for  $V^- = \text{GND} = 0\text{V}$ ,  $V^+ = 5\text{V}$ ,  $V_{\text{CM}} = V_{\text{OUT}} = 2.5\text{V}$ ,  $I_{\text{R}} = 100\ \mu\text{A}$ , FEEDBACK pin shorted to GND, unless otherwise specified. Limits in standard typeface are for  $T_{\text{J}} = 25^\circ\text{C}$ ; limits in **boldface type** apply over the **Operating Temperature Range**.

Symbol	Parameter	Conditions	Typical (Note 7)	LM613AM LM613AI Limits (Note 8)	LM613M LM613I LM613C Limits (Note 8)	Units
<b>COMPARATORS</b>						
$I_{\text{LEAK}}$	Output Leakage Current	$V^+_{\text{IN}} = 1\text{V}$ , $V^-_{\text{IN}} = 0\text{V}$ , $V_{\text{OUT}} = 36\text{V}$ (32V for LM613C)	0.1 <b>0.2</b>	10	10	$\mu\text{A}$ (Max) $\mu\text{A}$ (Max)
<b>VOLTAGE REFERENCE</b>						
$V_{\text{R}}$	Voltage Reference	(Note 10)	1.244	1.2365 1.2515 ( $\pm 0.6\%$ )	1.2191 1.2689 ( $\pm 2\%$ )	V (Min) V (Max)
$\frac{\Delta V_{\text{R}}}{\Delta T}$	Average Temp. Drift	(Note 11)	<b>10</b>	<b>80</b>	<b>150</b>	ppm/ $^\circ\text{C}$ (Max)
$\frac{\Delta V_{\text{R}}}{\Delta T_{\text{J}}}$	Hysteresis	(Note 12)	<b>3.2</b>			$\mu\text{V}/^\circ\text{C}$
$\frac{\Delta V_{\text{R}}}{\Delta I_{\text{R}}}$	$V_{\text{R}}$ Change with Current	$V_{\text{R}(100\ \mu\text{A})} - V_{\text{R}(17\ \mu\text{A})}$	0.05 <b>0.1</b>	1 <b>1.1</b>	1 <b>1.1</b>	mV (Max) mV (Max)
		$V_{\text{R}(10\ \text{mA})} - V_{\text{R}(100\ \mu\text{A})}$ (Note 13)	1.5 <b>2.0</b>	5 <b>5.5</b>	5 <b>5.5</b>	mV (Max) mV (Max)
R	Resistance	$\Delta V_{\text{R}(10 \rightarrow 0.1\ \text{mA})}/9.9\ \text{mA}$ $\Delta V_{\text{R}(100 \rightarrow 17\ \mu\text{A})}/83\ \mu\text{A}$	<b>0.2</b> <b>0.6</b>	<b>0.56</b> <b>13</b>	<b>0.56</b> <b>13</b>	$\Omega$ (Max) $\Omega$ (Max)
$\frac{V_{\text{R}}}{\Delta V_{\text{RO}}}$	$V_{\text{R}}$ Change with High $V_{\text{RO}}$	$V_{\text{R}(V_{\text{ro}} = V_{\text{r}})} - V_{\text{R}(V_{\text{ro}} = 6.3\text{V})}$ (5.06V between Anode and FEEDBACK)	2.5 <b>2.8</b>	7 <b>10</b>	7 <b>10</b>	mV (Max) mV (Max)
$\frac{V_{\text{R}}}{\Delta V^+}$	$V_{\text{R}}$ Change with $V_{\text{ANODE}}$ Change	$V_{\text{R}(V^+ = 5\text{V})} - V_{\text{R}(V^+ = 36\text{V})}$ ( $V^+ = 32\text{V}$ for LM613C)	0.1 <b>0.1</b>	1.2 <b>1.3</b>	1.2 <b>1.3</b>	mV (Max) mV (Max)
		$V_{\text{R}(V^+ = 5\text{V})} - V_{\text{R}(V^+ = 3\text{V})}$	0.01 <b>0.01</b>	1 <b>1.5</b>	1 <b>1.5</b>	mV (Max) mV (Max)
$I_{\text{FB}}$	FEEDBACK Bias Current	$V_{\text{ANODE}} \leq V_{\text{FB}} \leq 5.06\text{V}$	22 <b>29</b>	35 <b>40</b>	50 <b>55</b>	nA (Max) nA (Max)
$e_{\text{n}}$	$V_{\text{R}}$ Noise	10 Hz to 10 kHz, $V_{\text{RO}} = V_{\text{R}}$	30			$\mu\text{V}_{\text{RMS}}$

## Electrical Characteristics (Continued)

**Note 1:** Absolute maximum ratings indicate limits beyond which damage to the component may occur. Electrical specifications do not apply when operating the device beyond its rated operating conditions.

**Note 2:** Input voltage above  $V^+$  is allowed. As long as one input pin voltage remains inside the common-mode range, the comparator will deliver the correct output.

**Note 3:** More accurately, it is excessive current flow, with resulting excess heating, that limits the voltages on all pins. When any pin is pulled a diode drop below  $V^-$ , a parasitic NPN transistor turns ON. No latch-up will occur as long as the current through that pin remains below the Maximum Rating. Operation is undefined and unpredictable when any parasitic diode or transistor is conducting.

**Note 4:** Simultaneous short-circuit of multiple comparators while using high supply voltages may force junction temperature above maximum, and thus should not be continuous.

**Note 5:** Junction temperature may be calculated using  $T_J = T_A + P_D \theta_{JA}$ . The given thermal resistance is worst-case for packages in sockets in still air. For packages soldered to copper-clad board with dissipation from one comparator or reference output transistor, nominal  $\theta_{JA}$  is 90°C/W for the N package, and 135°C/W for the WM package.

**Note 6:** Human body model, 100 pF discharged through a 1.5 kΩ resistor.

**Note 7:** Typical values in standard typeface are for  $T_J = 25^\circ\text{C}$ ; values in **bold face type** apply for the full operating temperature range. These values represent the most likely parametric norm.

**Note 8:** All limits are guaranteed at room temperature (standard type face) or at operating temperature extremes (**bold type face**).

**Note 9:** Slew rate is measured with the op amp in a voltage follower configuration. For rising slew rate, the input voltage is driven from 5V to 25V, and the output voltage transition is sampled at 10V and @ 20V. For falling slew rate, the input voltage is driven from 25V to 5V, and the output voltage transition is sampled at 20V and 10V.

**Note 10:**  $V_R$  is the Cathode-to-feedback voltage, nominally 1.244V.

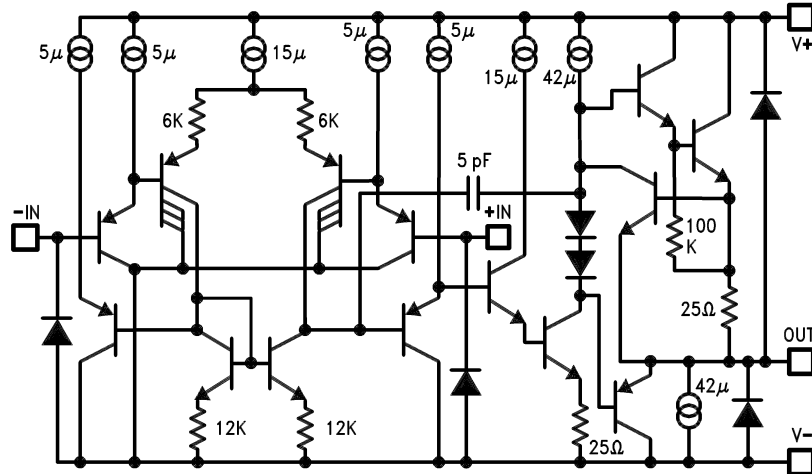
**Note 11:** Average reference drift is calculated from the measurement of the reference voltage at 25°C and at the temperature extremes. The drift, in ppm/°C, is  $10^6 \cdot \Delta V_R / (V_{R[25^\circ\text{C}]} \cdot \Delta T_J)$ , where  $\Delta V_R$  is the lowest value subtracted from the highest,  $V_{R[25^\circ\text{C}]}$  is the value at 25°C, and  $\Delta T_J$  is the temperature range. This parameter is guaranteed by design and sample testing.

**Note 12:** Hysteresis is the change in  $V_R$  caused by a change in  $T_J$ , after the reference has been "dehysteresized". To dehysteresize the reference; that is minimize the hysteresis to the typical value, its junction temperature should be cycled in the following pattern, spiraling in toward 25°C: 25°C, 85°C, -40°C, 70°C, 0°C, 25°C.

**Note 13:** Low contact resistance is required for accurate measurement.

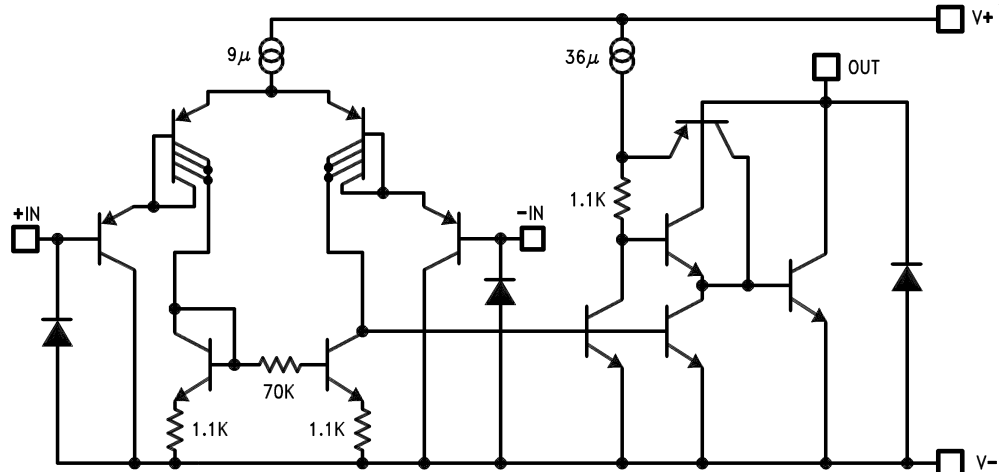
# Simplified Schematic Diagrams

Op Amp



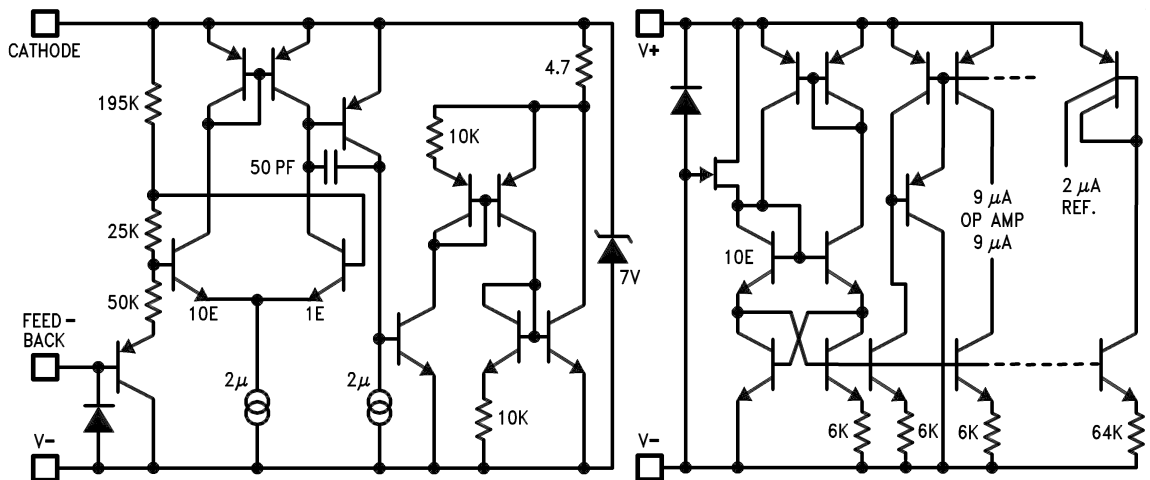
00922602

Comparator



00922603

Reference/Bias

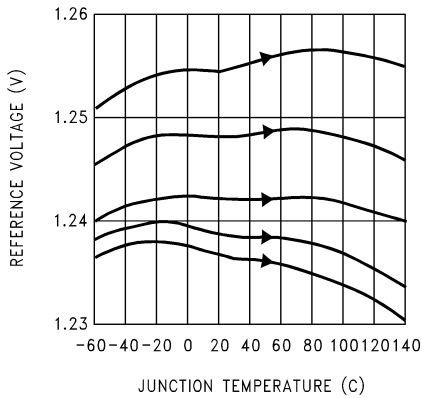


00922604

# Typical Performance Characteristics (Reference)

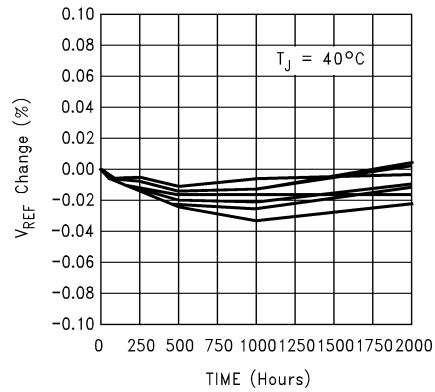
$T_J = 25^\circ\text{C}$ , FEEDBACK pin shorted to  $V^- = 0\text{V}$ , unless otherwise noted

Reference Voltage vs Temp.



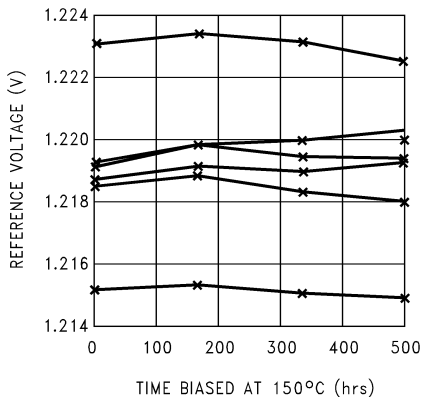
00922649

Reference Voltage Drift



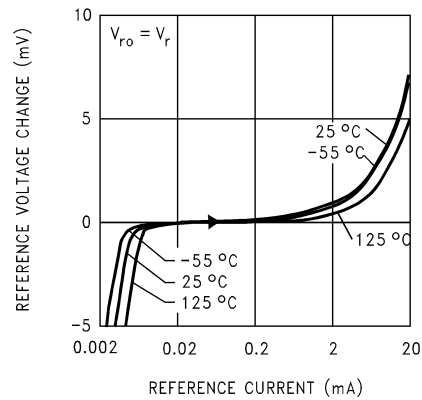
00922650

Accelerated Reference Voltage Drift vs Time



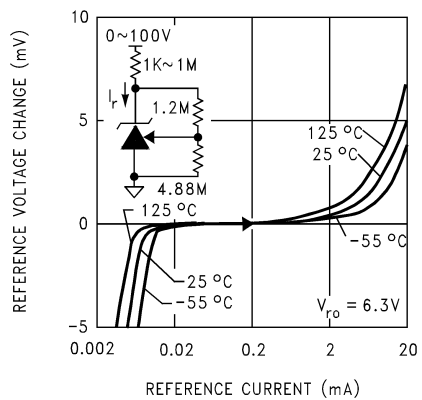
00922651

Reference Voltage vs Current and Temperature



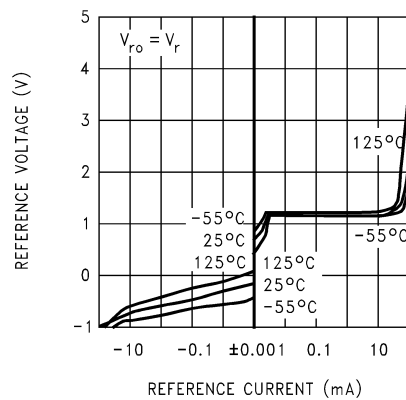
00922652

Reference Voltage vs Current and Temperature



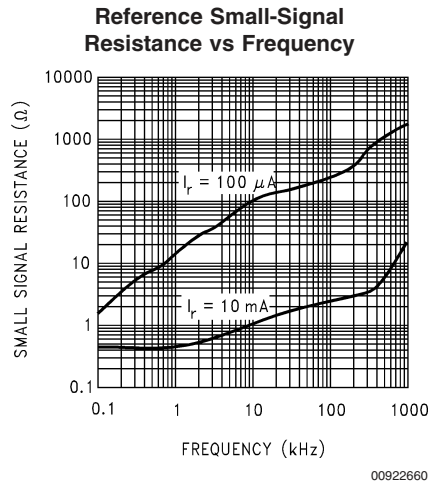
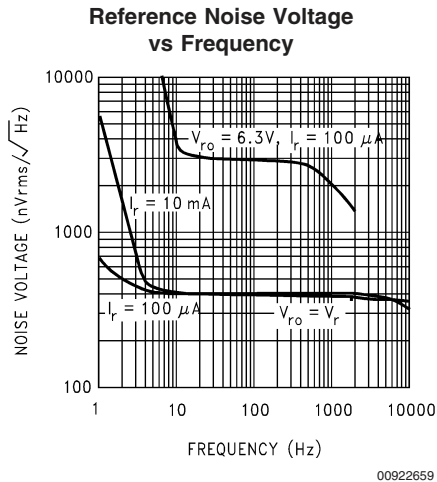
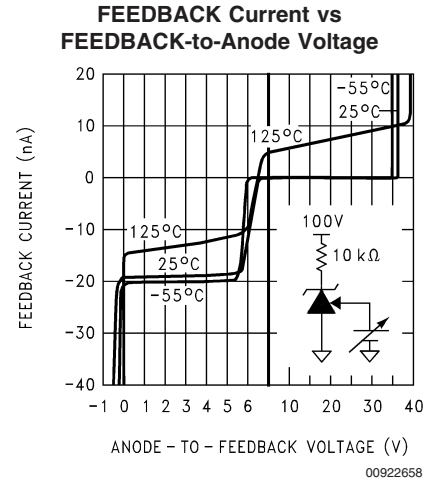
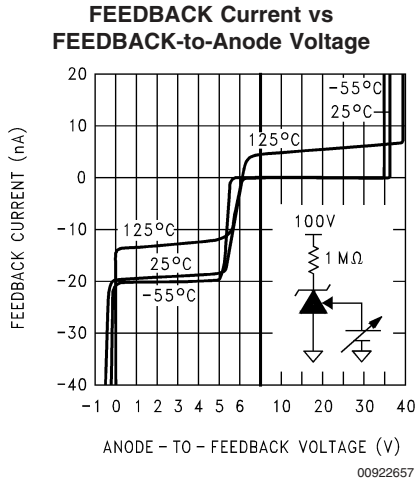
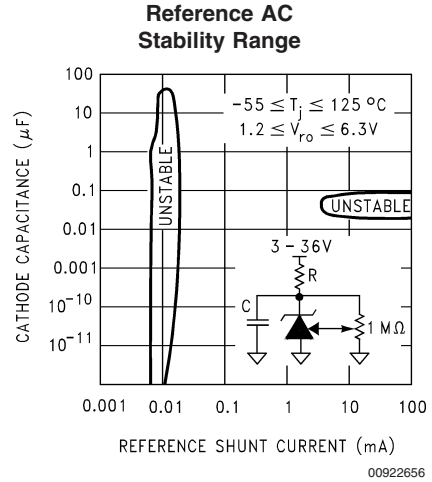
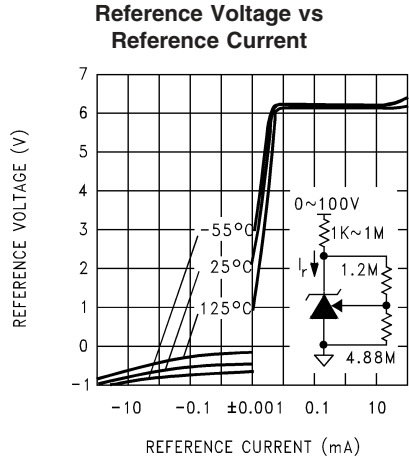
00922653

Reference Voltage vs Reference Current



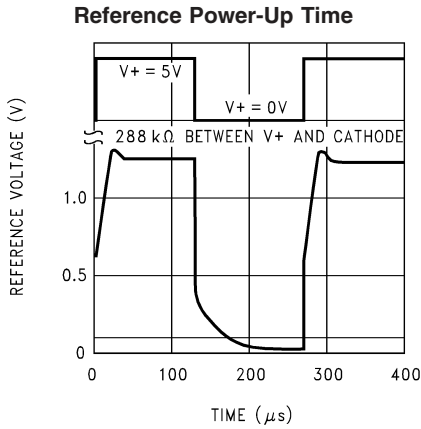
00922654

**Typical Performance Characteristics (Reference)**  $T_J = 25^\circ\text{C}$ , FEEDBACK pin shorted to  $V^- = 0\text{V}$ , unless otherwise noted (Continued)

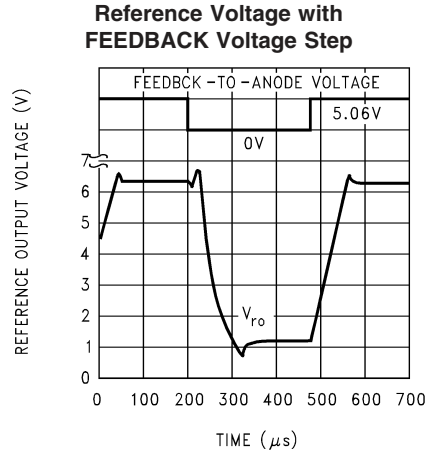




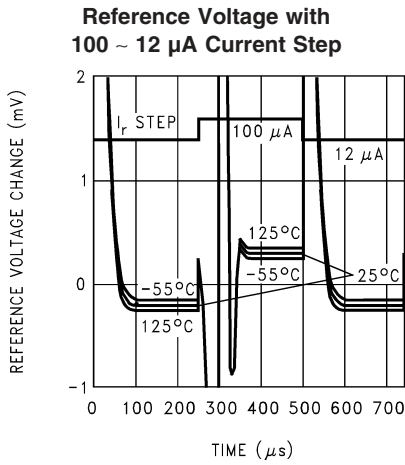
**Typical Performance Characteristics (Reference)**  $T_J = 25^\circ\text{C}$ , FEEDBACK pin shorted to  $V^- = 0\text{V}$ , unless otherwise noted (Continued)



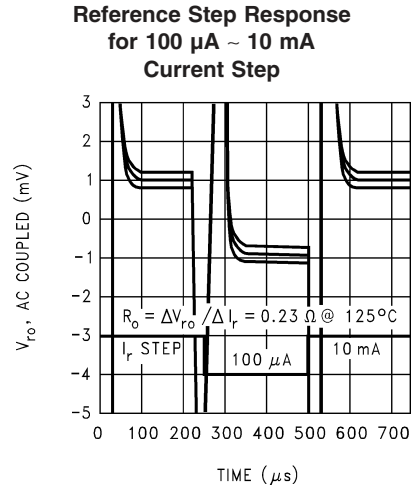
00922661



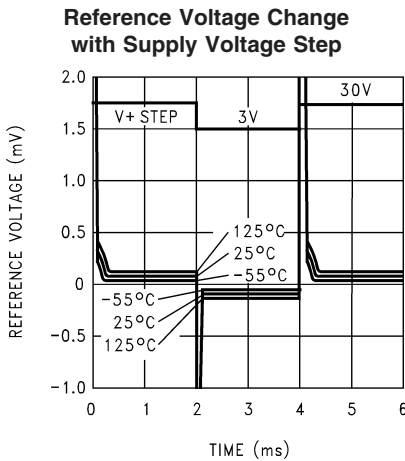
00922662



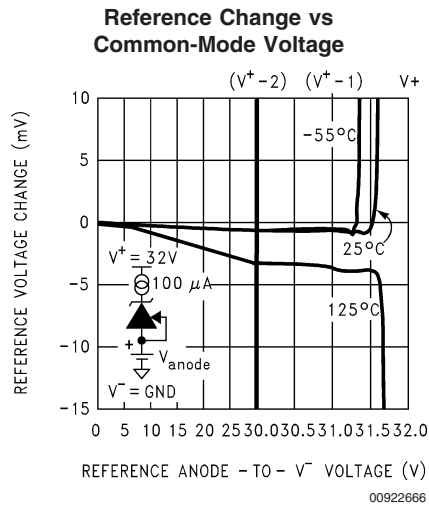
00922663



00922664



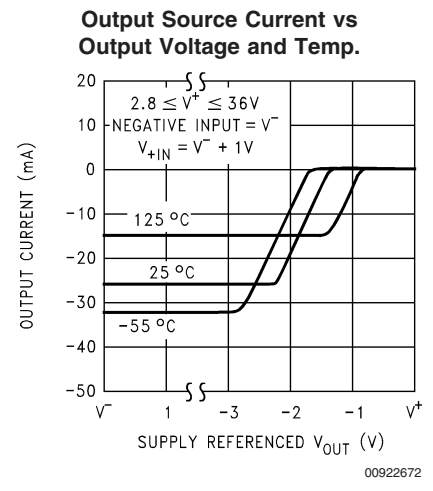
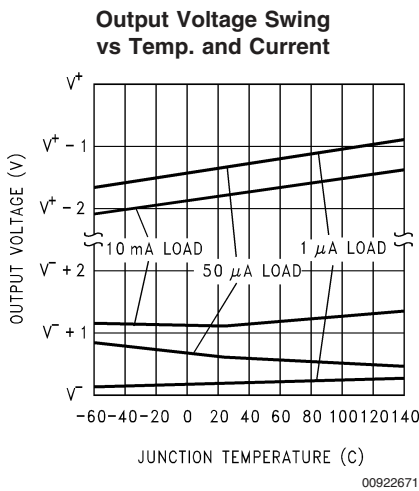
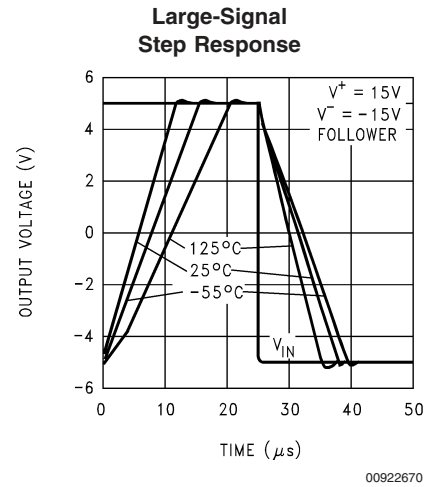
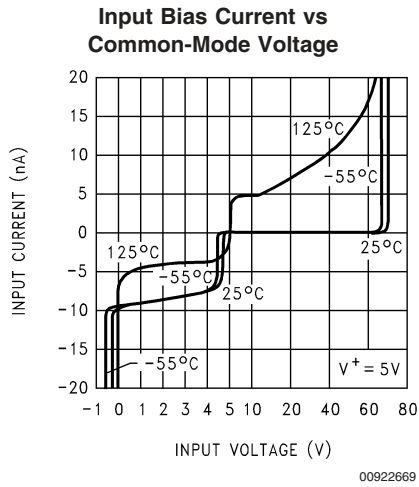
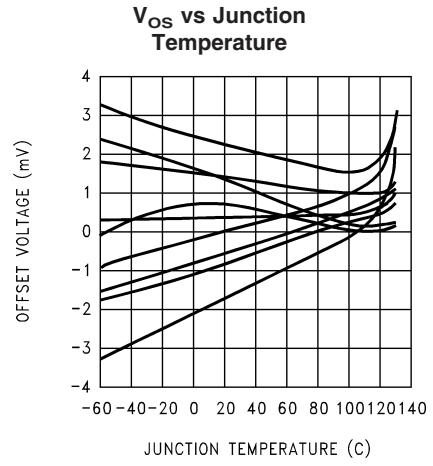
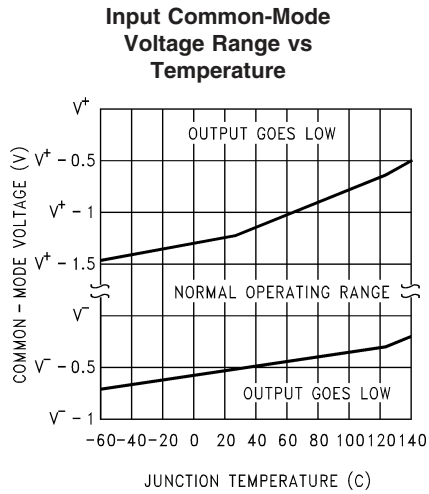
00922665



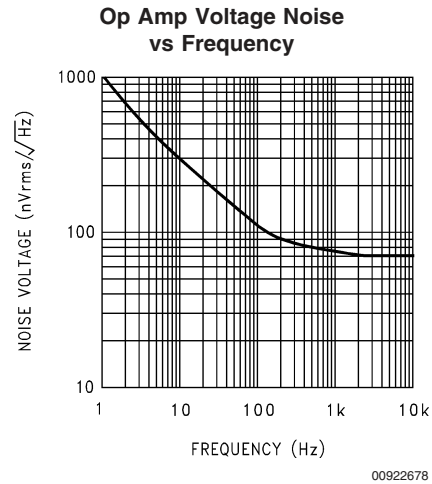
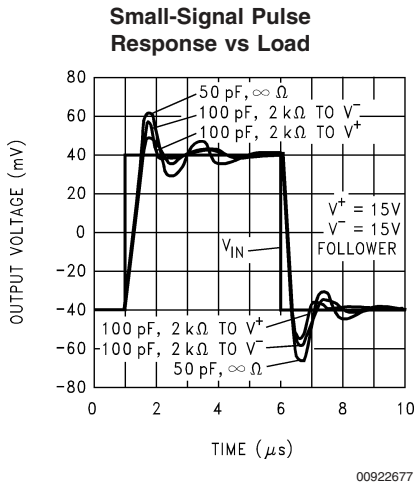
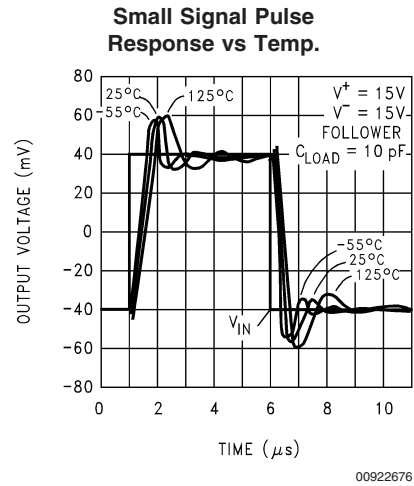
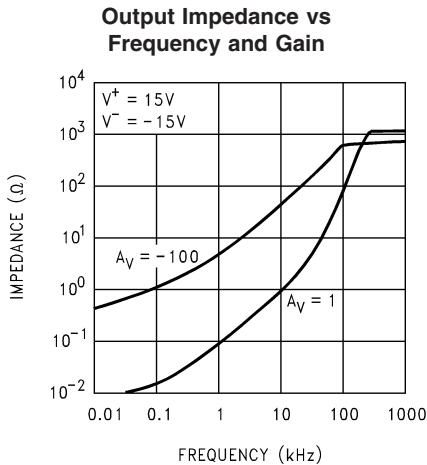
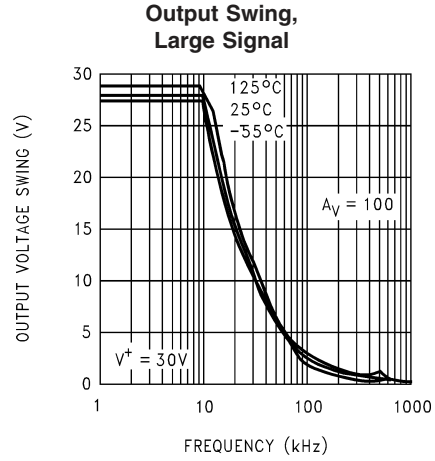
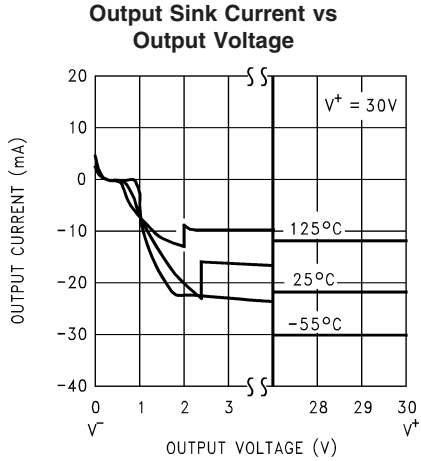
00922666

# Typical Performance Characteristics (Op Amps)

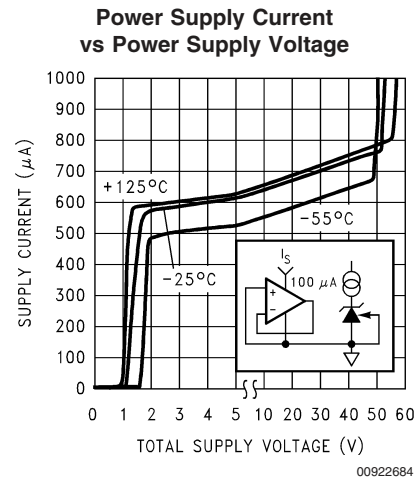
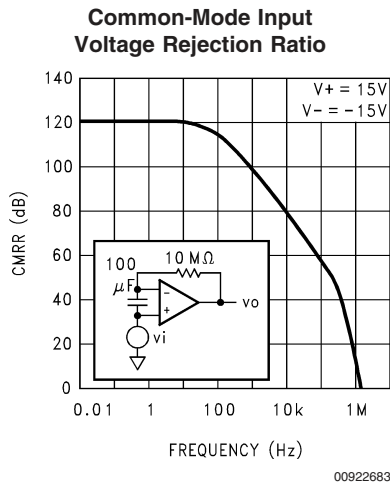
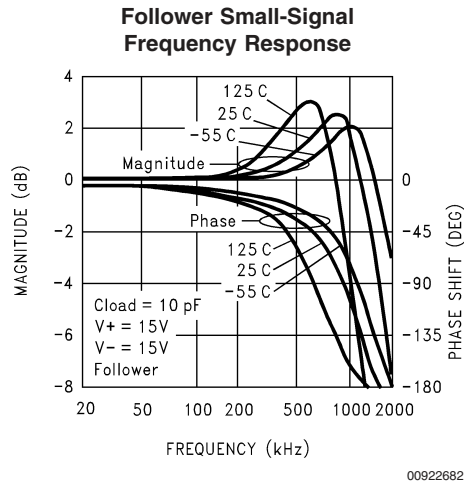
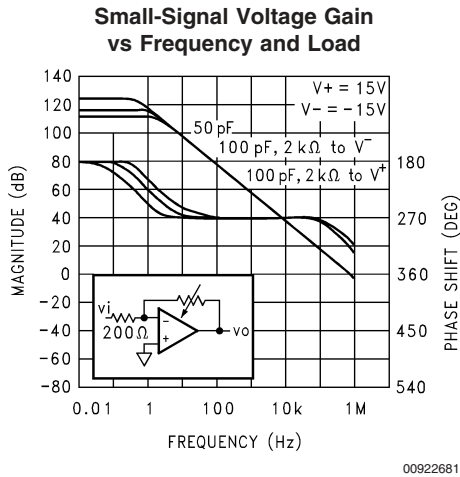
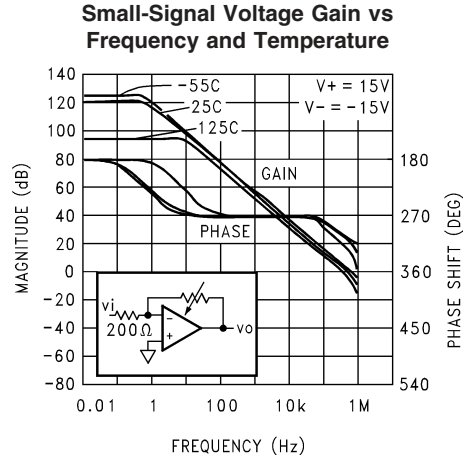
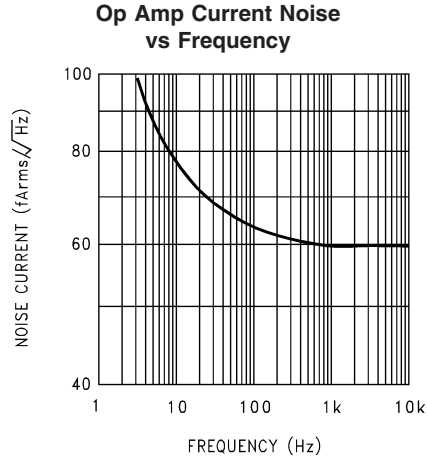
$V^+ = 5V, V^- = GND = 0V, V_{CM} = V^+/2, V_{OUT} = V^+/2, T_J = 25^\circ C$ , unless otherwise noted



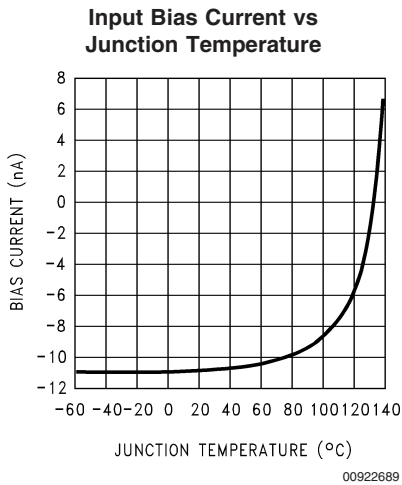
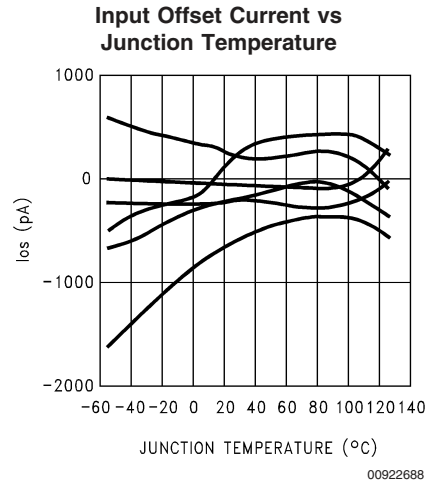
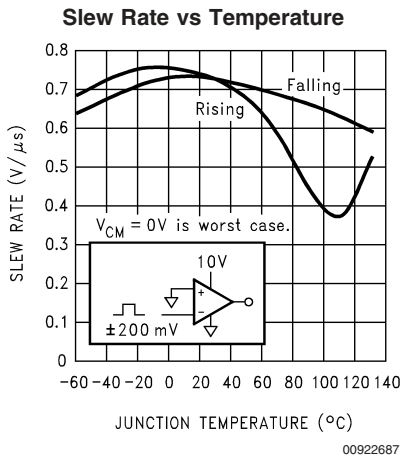
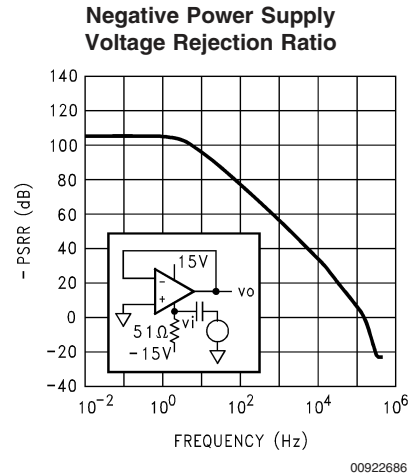
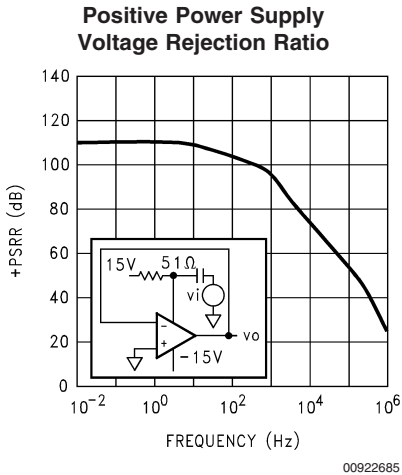
**Typical Performance Characteristics (Op Amps)**  $V^+ = 5V, V^- = GND = 0V, V_{CM} = V^+/2, V_{OUT} = V^+/2, T_J = 25^\circ C$ , unless otherwise noted (Continued)



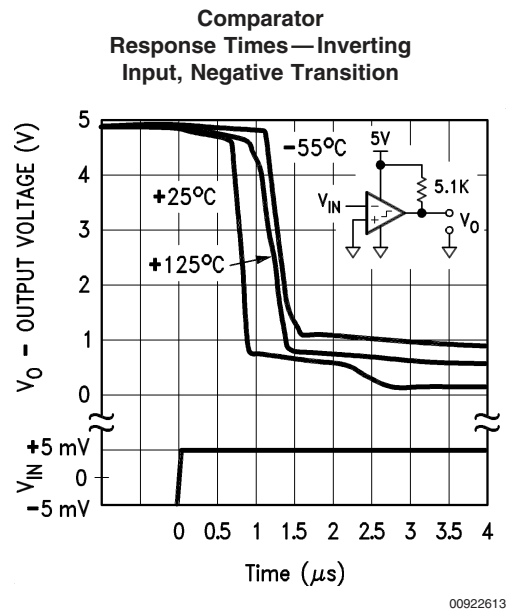
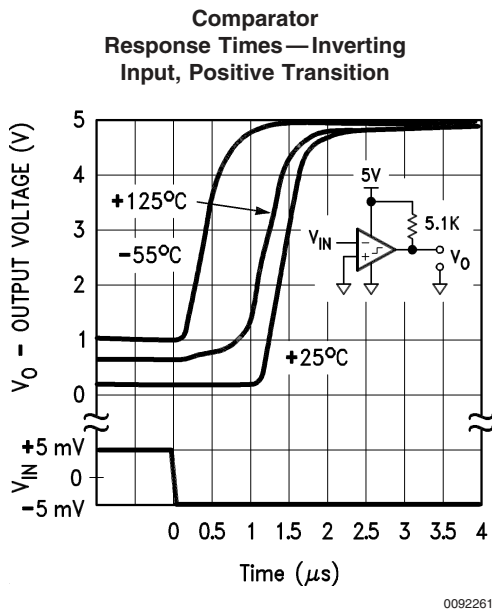
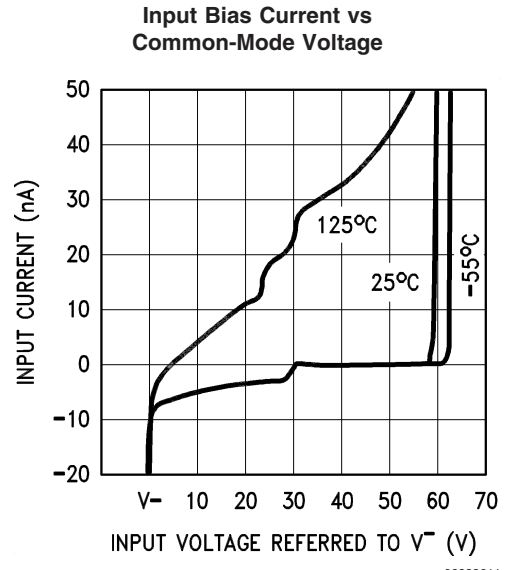
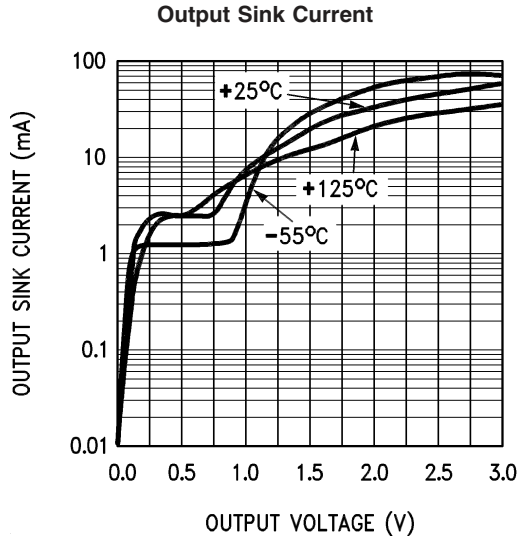
**Typical Performance Characteristics (Op Amps)**  $V^+ = 5V$ ,  $V^- = GND = 0V$ ,  $V_{CM} = V^+/2$ ,  $V_{OUT} = V^+/2$ ,  $T_J = 25^\circ C$ , unless otherwise noted (Continued)



**Typical Performance Characteristics (Op Amps)**  $V^+ = 5V$ ,  $V^- = GND = 0V$ ,  $V_{CM} = V^+/2$ ,  $V_{OUT} = V^+/2$ ,  $T_J = 25^\circ C$ , unless otherwise noted (Continued)

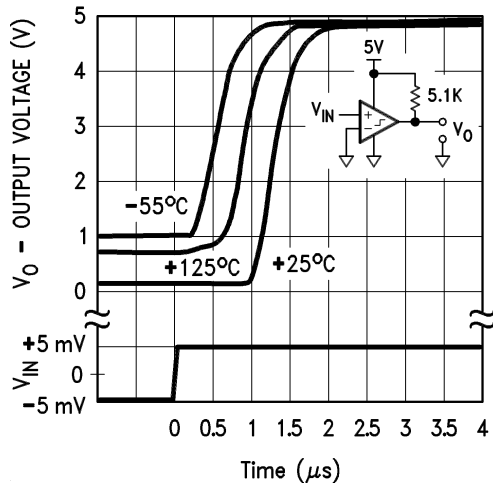


# Typical Performance Characteristics (Comparators)

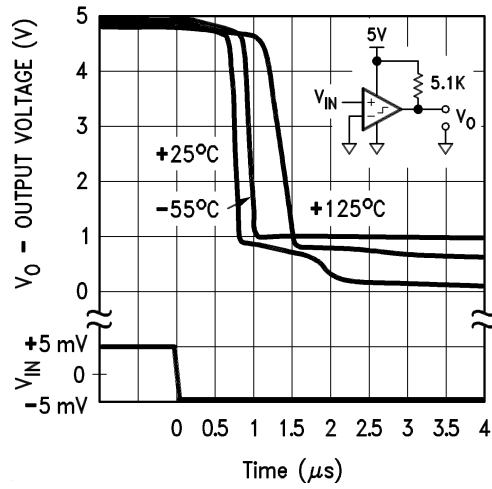


Typical Performance Characteristics (Comparators) (Continued)

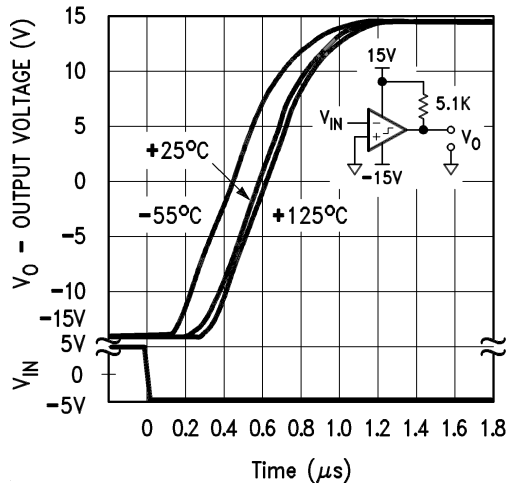
Comparator  
Response Times—Non-Inverting  
Input, Positive Transition



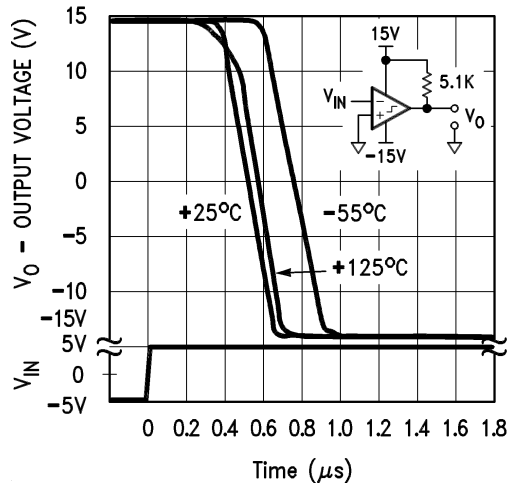
Comparator  
Response Times—Non-Inverting  
Input, Negative Transition



Comparator  
Response Times—Inverting  
Input, Positive Transition

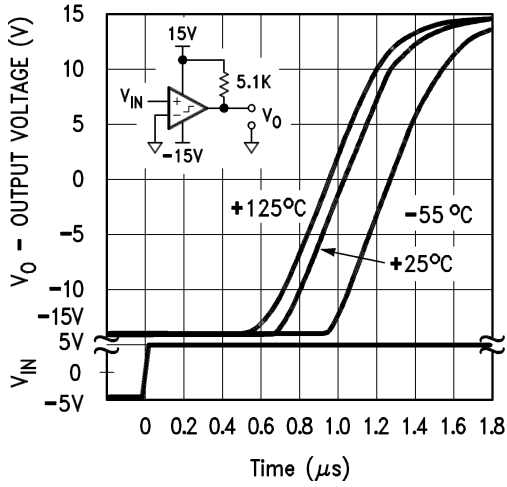


Comparator  
Response Times—Inverting  
Input, Negative Transition



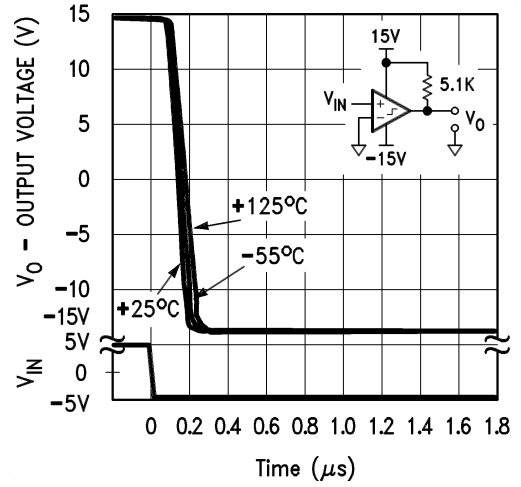
## Typical Performance Characteristics (Comparators) (Continued)

**Comparator**  
Response Times—Non-Inverting  
Input, Positive Transition



00922618

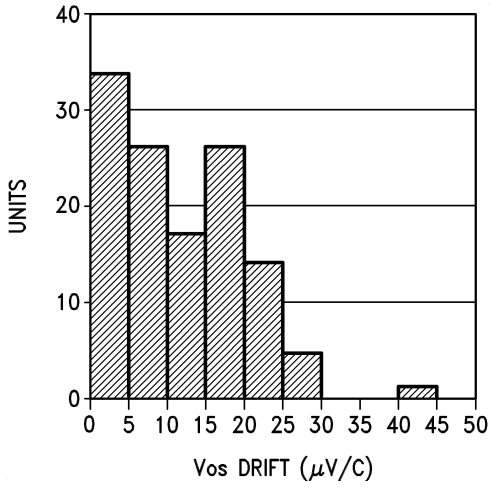
**Comparator**  
Response Times—Non-Inverting  
Input, Negative Transition



00922619

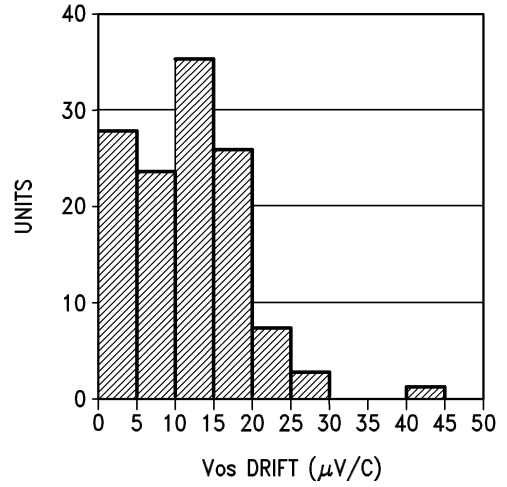
## Typical Performance Distributions

**Average  $V_{OS}$  Drift**  
Military Temperature Range



00922620

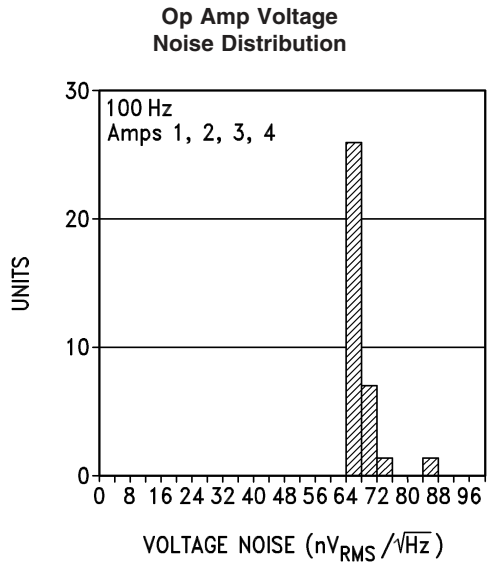
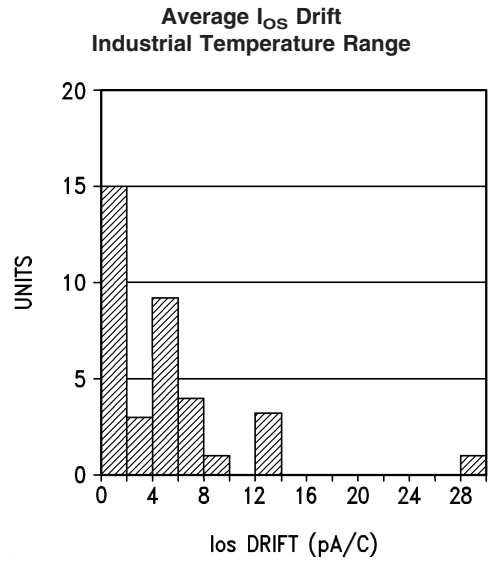
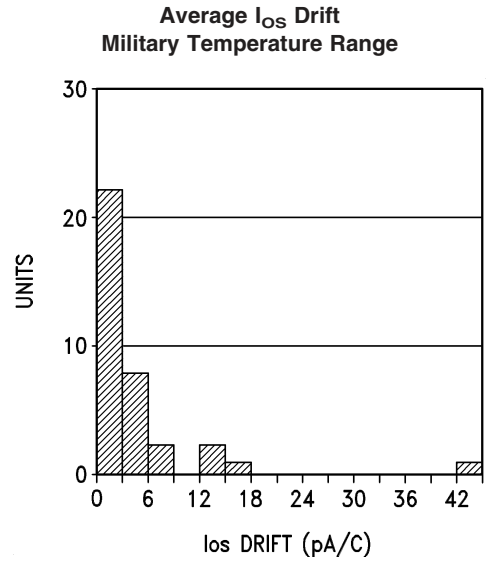
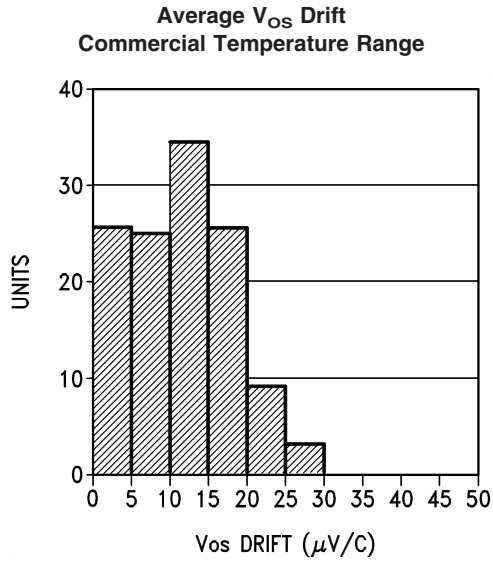
**Average  $V_{OS}$  Drift**  
Industrial Temperature Range



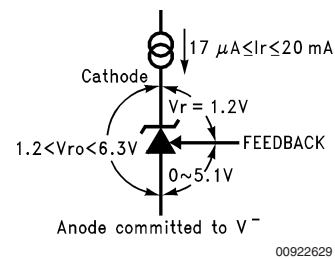
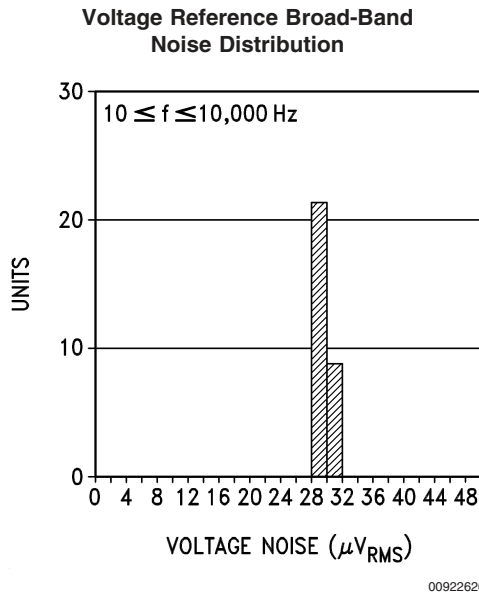
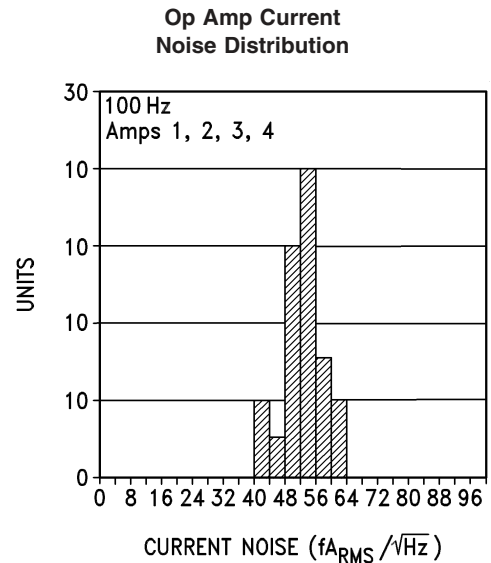
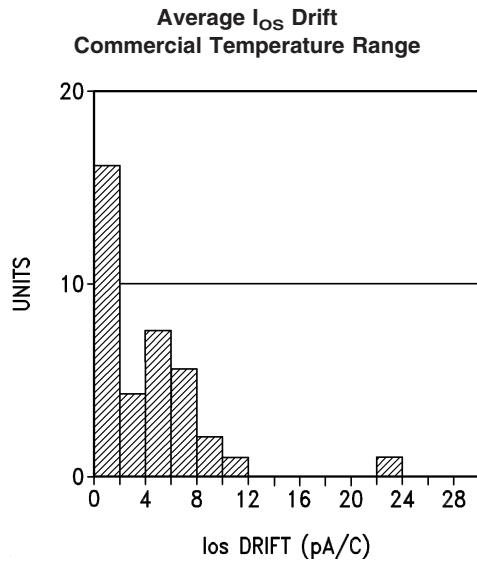
00922621



Typical Performance Distributions (Continued)



## Typical Performance Distributions (Continued)



**FIGURE 1. Voltage Associated with Reference (current source  $I_r$  is external)**

The reference equivalent circuit reveals how  $V_r$  is held at the constant 1.2V by feedback, and how the FEEDBACK pin passes little current.

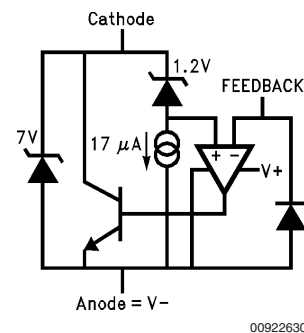
To generate the required reverse current, typically a resistor is connected from a supply voltage higher than the reference voltage. Varying that voltage, and so varying  $I_r$ , has small effect with the equivalent series resistance of less than an ohm at the higher currents. Alternatively, an active current source, such as the LM134 series, may generate  $I_r$ .

## Application Information

### VOLTAGE REFERENCE

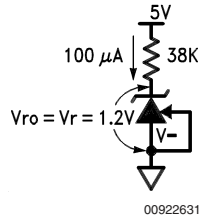
#### Reference Biasing

The voltage reference is of a shunt regulator topology that models as a simple zener diode. With current  $I_r$  flowing in the "forward" direction there is the familiar diode transfer function.  $I_r$  flowing in the reverse direction forces the reference voltage to be developed from cathode to anode. The cathode may swing from a diode drop below  $V^-$  to the reference voltage or to the avalanche voltage of the parallel protection diode, nominally 7V. A 6.3V reference with  $V^+ = 3\text{V}$  is allowed.



**FIGURE 2. Reference Equivalent Circuit**

**Application Information** (Continued)

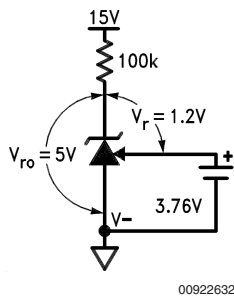


**FIGURE 3. 1.2V Reference**

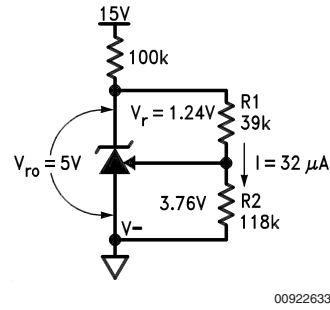
Capacitors in parallel with the reference are allowed. See the Reference AC Stability Range typical curve for capacitance values—from 20 µA to 3 mA any capacitor value is stable. With the reference’s wide stability range with resistive and capacitive loads, a wide range of RC filter values will perform noise filtering.

**Adjustable Reference**

The FEEDBACK pin allows the reference output voltage,  $V_{ro}$ , to vary from 1.24V to 6.3V. The reference attempts to hold  $V_r$  at 1.24V. If  $V_r$  is above 1.24V, the reference will conduct current from Cathode to Anode; FEEDBACK current always remains low. If FEEDBACK is connected to Anode, then  $V_{ro} = V_r = 1.24V$ . For higher voltages FEEDBACK is held at a constant voltage above Anode—say 3.76V for  $V_{ro} = 5V$ . Connecting a resistor across the constant  $V_r$  generates a current  $I = R1/V_r$  flowing from Cathode into FEEDBACK node. A Thevenin equivalent 3.76V is generated from FEEDBACK to Anode with  $R2 = 3.76/I$ . Keep  $I$  greater than one thousand times larger than FEEDBACK bias current for <0.1% error— $I \geq 32 \mu A$  for the military grade over the military temperature range ( $I \geq 5.5 \mu A$  for a 1% untrimmed error for a commercial part).



**FIGURE 4. Thevenin Equivalent of Reference with 5V Output**

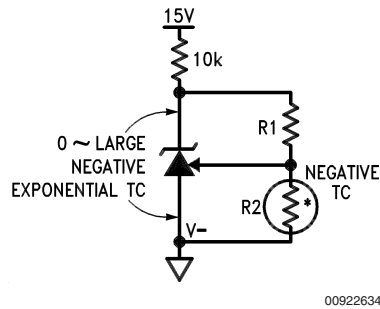


$$R1 = Vr/I = 1.24/32\mu = 39k$$

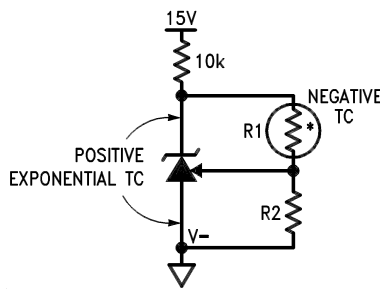
$$R2 = R1 \{(Vro/Vr) - 1\} = 39k \{(5/1.24) - 1\} = 118k$$

**FIGURE 5. Resistors R1 and R2 Program Reference Output Voltage to be 5V**

Understanding that  $V_r$  is fixed and that voltage sources, resistors, and capacitors may be tied to the FEEDBACK pin, a range of  $V_r$  temperature coefficients may be synthesized.

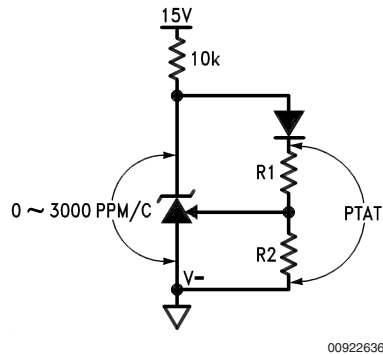


**FIGURE 6. Output Voltage has Negative Temperature Coefficient (TC) if R2 has Negative TC**



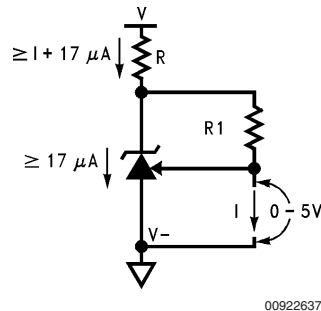
**FIGURE 7. Output Voltage has Positive TC if R1 has Negative TC**

## Application Information (Continued)



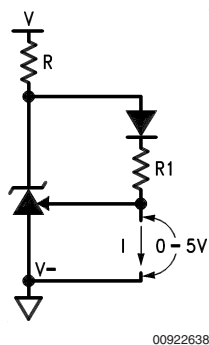
**FIGURE 8. Diode in Series with R1 Causes Voltage Across R1 and R2 to be Proportional to Absolute Temperature (PTAT)**

Connecting a resistor across Cathode-to-FEEDBACK creates a 0 TC current source, but a range of TCs may be synthesized.

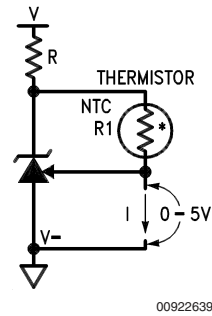


$$I = V_r/R1 = 1.24/R1$$

**FIGURE 9. Current Source is Programmed by R1**



**FIGURE 10. Proportional-to-Absolute-Temperature Current Source**



**FIGURE 11. Negative-TC Current Source**

### Reference Hysteresis

The reference voltage depends, slightly, on the thermal history of the die. Competitive micro-power products vary—always check the data sheet for any given device. Do not assume that no specification means no hysteresis.

### OPERATIONAL AMPLIFIERS AND COMPARATORS

Any amp, comparator, or the reference may be biased in any way with no effect on the other sections of the LM613, except when a substrate diode conducts, see Electrical Characteristics (Note 1). For example, one amp input may be outside the common-mode range, another amp may be operating as a comparator, and all other sections may have all terminals floating with no effect on the others. Tying inverting input to output and non-inverting input to  $V^-$  on unused amps is preferred. Unused comparators should have non-inverting input and output tied to  $V^+$ , and inverting input tied to  $V^-$ . Choosing operating points that cause oscillation, such as driving too large a capacitive load, is best avoided.

### Op Amp Output Stage

These op amps, like the LM124 series, have flexible and relatively wide-swing output stages. There are simple rules to optimize output swing, reduce cross-over distortion, and optimize capacitive drive capability:

1. **Output Swing:** Unloaded, the 42  $\mu\text{A}$  pull-down will bring the output within 300 mV of  $V^-$  over the military temperature range. If more than 42  $\mu\text{A}$  is required, a resistor from output to  $V^-$  will help. Swing across any load may be improved slightly if the load can be tied to  $V^+$ , at the cost of poorer sinking open-loop voltage gain.
2. **Cross-Over Distortion:** The LM613 has lower cross-over distortion (a 1  $V_{BE}$  deadband versus 3  $V_{BE}$  for the LM124), and increased slew rate as shown in the characteristic curves. A resistor pull-up or pull-down will force class-A operation with only the PNP or NPN output transistor conducting, eliminating cross-over distortion.
3. **Capacitive Drive:** Limited by the output pole caused by the output resistance driving capacitive loads, a pull-down resistor conducting 1 mA or more reduces the output stage NPN  $r_o$  until the output resistance is that of the current limit 25 $\Omega$ . 200 pF may then be driven without oscillation.

## Application Information (Continued)

### Comparator Output Stage

The comparators, like the LM139 series, have open-collector output stages. A pull-up resistor must be added from each output pin to a positive voltage for the output transistor to switch properly. When the output transistor is OFF, the output voltage will be this external positive voltage.

For the output voltage to be under the TTL-low voltage threshold when the output transistor is ON, the output current must be less than 8 mA (over temperature). This impacts the minimum value of pull-up resistor.

The offset voltage may increase when the output voltage is low and the output current is less than 30  $\mu\text{A}$ . Thus, for best accuracy, the pull-up resistor value should be low enough to allow the output transistor to sink more than 30  $\mu\text{A}$ .

### Op Amp and Comparator Input Stage

The lateral PNP input transistors, unlike those of most op amps, have  $BV_{EBO}$  equal to the absolute maximum supply voltage. Also, they have no diode clamps to the positive supply nor across the inputs. These features make the inputs look like high impedances to input sources producing large differential and common-mode voltages.

# Typical Applications

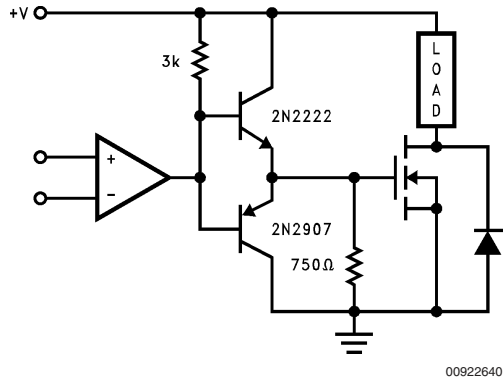


FIGURE 12. High Current, High Voltage Switch

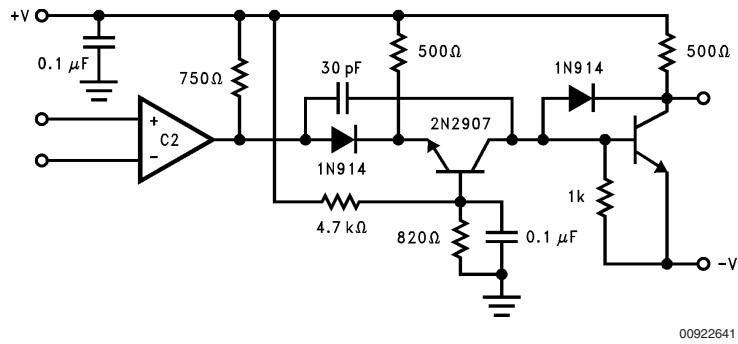
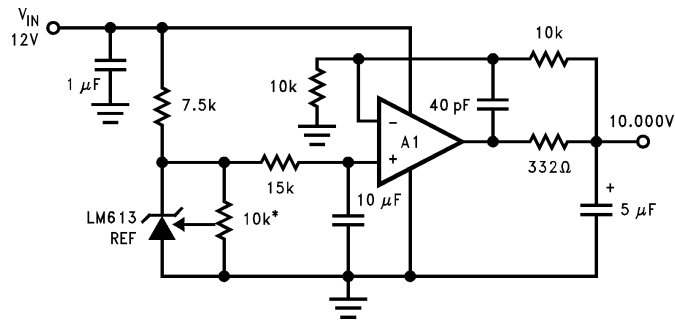


FIGURE 13. High Speed Level Shifter. Response time is approximately 1.5 μs, where output is either approximately +V or -V.



\*10k must be low  
t.c. trimpot

FIGURE 14. Ultra Low Noise, 10.000V Reference. Total output noise is typically 14 μV<sub>RMS</sub>.

## Typical Applications (Continued)

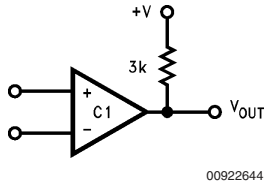


FIGURE 15. Basic Comparator

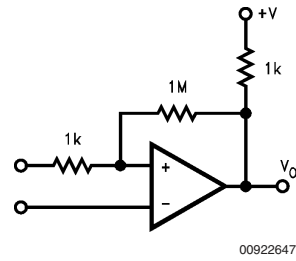


FIGURE 18. Comparator with Hysteresis ( $\Delta V_H = +V(1k/1M)$ )

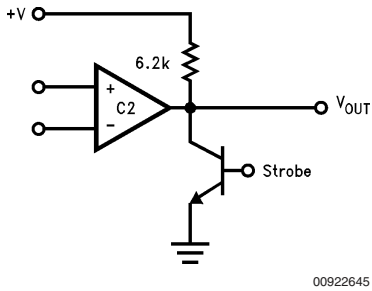


FIGURE 16. Basic Comparator with External Strobe

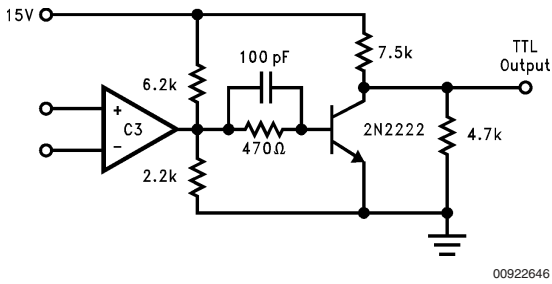


FIGURE 17. Wide-Input Range Comparator with TTL Output

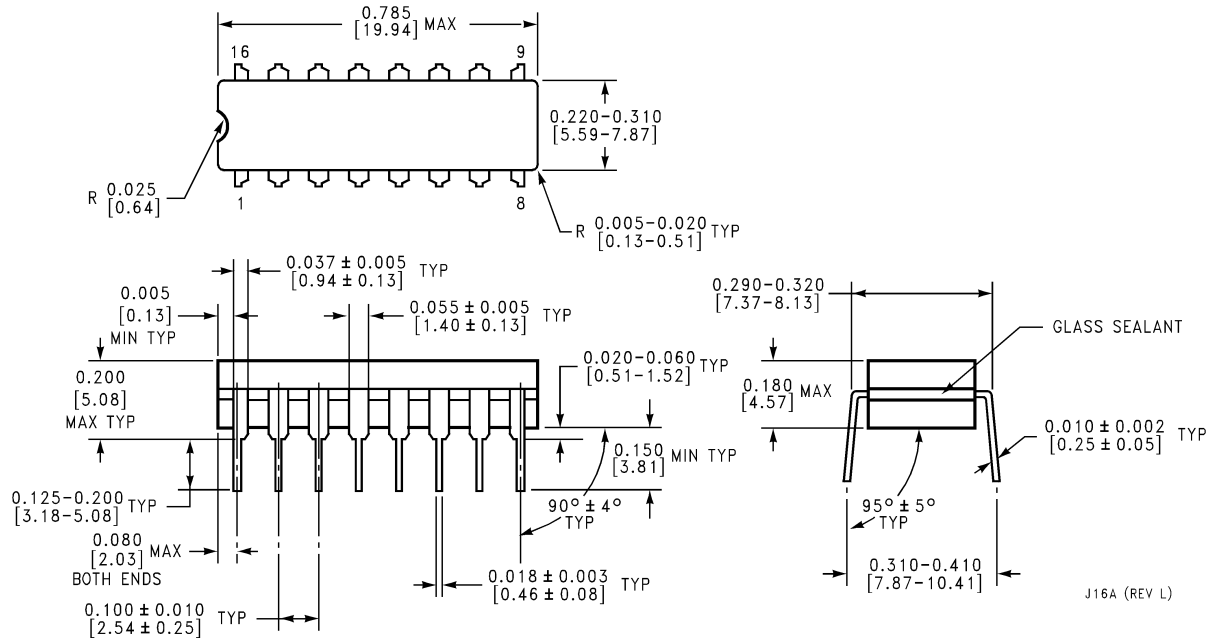
## Ordering Information

Reference Tolerance & $V_{OS}$	Temperature Range		Package	NSC Drawing
	Military $-55^{\circ}\text{C} \leq T_A \leq +125^{\circ}\text{C}$	Industrial $-40^{\circ}\text{C} \leq T_A \leq +85^{\circ}\text{C}$		
$\pm 0.6\%$ 80 ppm/ $^{\circ}\text{C}$ Max. $V_{OS} \leq 3.5$ mV	LM613AMJ/883 (Note 14)		16-Pin Ceramic DIP	J16A
$\pm 2.0\%$ 150 ppm/ $^{\circ}\text{C}$ Max. $V_{OS} \leq 5.0$ mV Max.		LM613IWM LM613IWMX	16-Pin Wide Surface Mount	M16B

**Note 14:** A military RETS 613AMX electrical test specification is available on request. The Military screened parts can also be procured as a Standard Military Drawing.

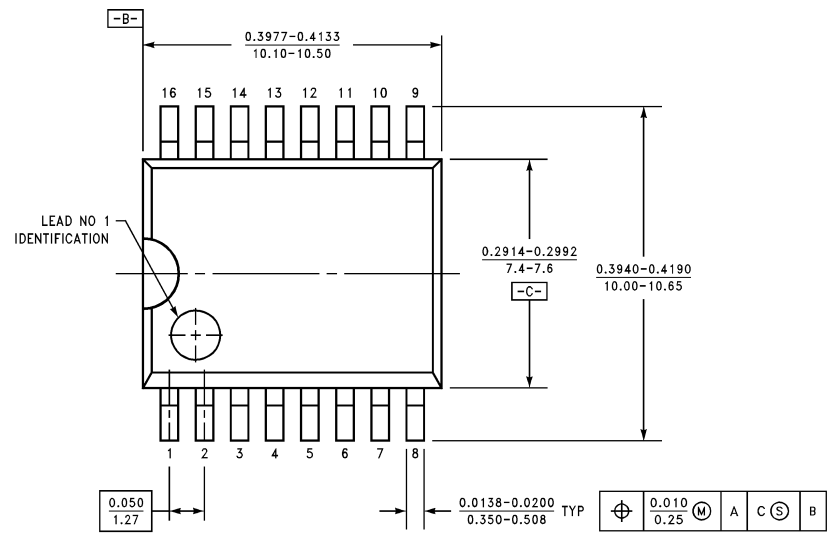
**Physical Dimensions** inches (millimeters)

unless otherwise noted



J16A (REV L)

**16-Lead Ceramic Dual-In-Line Package (J)**  
**Order Number LM613AMJ/883**  
**NS Package Number J16A**



M16B (REV F)

**16-Lead Small Outline Package (WM)**  
**Order Number LM613IWM or LM613IWMX**  
**NS Package Number M16B**



## Notes

### LIFE SUPPORT POLICY

NATIONAL'S PRODUCTS ARE NOT AUTHORIZED FOR USE AS CRITICAL COMPONENTS IN LIFE SUPPORT DEVICES OR SYSTEMS WITHOUT THE EXPRESS WRITTEN APPROVAL OF THE PRESIDENT AND GENERAL COUNSEL OF NATIONAL SEMICONDUCTOR CORPORATION. As used herein:

1. Life support devices or systems are devices or systems which, (a) are intended for surgical implant into the body, or (b) support or sustain life, and whose failure to perform when properly used in accordance with instructions for use provided in the labeling, can be reasonably expected to result in a significant injury to the user.
2. A critical component is any component of a life support device or system whose failure to perform can be reasonably expected to cause the failure of the life support device or system, or to affect its safety or effectiveness.

### BANNED SUBSTANCE COMPLIANCE

National Semiconductor certifies that the products and packing materials meet the provisions of the Customer Products Stewardship Specification (CSP-9-111C2) and the Banned Substances and Materials of Interest Specification (CSP-9-111S2) and contain no "Banned Substances" as defined in CSP-9-111S2.



**National Semiconductor**  
Americas Customer  
Support Center  
Email: [new.feedback@nsc.com](mailto:new.feedback@nsc.com)  
Tel: 1-800-272-9959

**National Semiconductor**  
Europe Customer Support Center  
Fax: +49 (0) 180-530 85 86  
Email: [europa.support@nsc.com](mailto:europa.support@nsc.com)  
Deutsch Tel: +49 (0) 69 9508 6208  
English Tel: +44 (0) 870 24 0 2171  
Français Tel: +33 (0) 1 41 91 8790

**National Semiconductor**  
Asia Pacific Customer  
Support Center  
Email: [ap.support@nsc.com](mailto:ap.support@nsc.com)

**National Semiconductor**  
Japan Customer Support Center  
Fax: 81-3-5639-7507  
Email: [jpn.feedback@nsc.com](mailto:jpn.feedback@nsc.com)  
Tel: 81-3-5639-7560

[www.national.com](http://www.national.com)